

# **Memorex®**

## **15 Channel GMR5 Radio**

**Model # MK 1995**

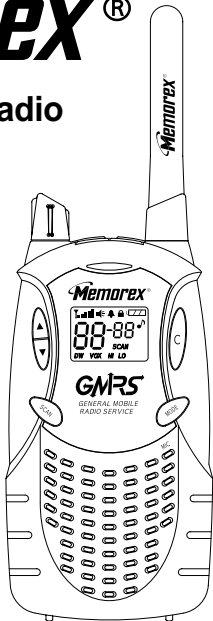

***Before operating your  
MK 1995, please read  
this instruction manual  
completely.***



## CAUTIONS

### GMRS LICENSE

USE OF THIS RADIO WITHIN THE UNITED STATES REQUIRES AN FCC GMRS LICENSE. AN INDIVIDUAL 18 YEARS OF AGE OR OLDER, WHO IS NOT A REPRESENTATIVE OF A FOREIGN GOVERNMENT, IS ELIGIBLE TO APPLY FOR A GMRS SYSTEM LICENSE. YOU WILL NEED TWO FORMS FROM THE FCC ; FCC FORM 159 AND FCC FORM 605 MAIN FORM AND SCHEDULE F. YOU CAN FIND THE FORMS ONLINE AT: [HTTP://WWW.FCC.GOV/FORMPAGE.HTML](http://www.fcc.gov/formpage.html), OR CALL 1-800-418-3676.

- When transmitting with a COMMUNICATOR, hold the COMMUNICATOR in a vertical position with its MICROPHONE 1 to 2 inches (2.5 to 5.0 cm) away from your mouth. Keep the ANTENNA at least 1 inch (2.5 cm) from your head and body.
- If you wear a COMMUNICATOR on your body, ensure that the ANTENNA is at least one inch (2.5 cm) from your body when transmitting.

**NOTE** : Please keep all packaging material for at least 90 days in case you need to return this product to your place of purchase or Memorex.

# Contents

<b>FCC NOTICE</b> . . . . .	1	CTCSS Sub-Channel Scan . . .	19
<b>Features</b> . . . . .	2	Key Lock . . . . .	19
<b>Controls and Indicators</b> . . .	3	Calling Another Party . . . .	20
<b>LCD Display Indicators</b> . . .	5	Monitor . . . . .	21
<b>Operation</b>		LCD Back-Lighting Lamp . . .	22
Installing The Batteries . . . .	6	TX/RX Indicator LED Lamp . . .	22
Recharging The Batteries . . .	7	Auto Power Saver . . . . .	22
Turning On Your Unit . . . . .	8	Low Battery Indicator . . . . .	23
Adjusting The Volume . . . . .	8	<b>External Microphone</b>	
Talking To Another Party . . .	8	<b>/ Speaker</b> . . . . .	24
Mode Button . . . . .	9	<b>Notes For Better</b>	
Selecting Main Channels . . . .	10	<b>Communication</b> . . . . .	25
Selecting Tone Code . . . . .	11	<b>Special Warning</b> . . . . .	26
Transmitting Power Hi/Low . . .	12	<b>Troubleshooting Guide</b> . . .	27
Dual Watch Mode . . . . .	13	<b>Special Note</b> . . . . .	28
VOX Mode . . . . .	14	<b>Specifications</b> . . . . .	29
Key Tone Setting . . . . .	15	<b>GMRS Channel Frequencies</b>	
Roger Beep Tone . . . . .	16	Main Channel Frequencies . . .	30
Selecting Call Tones . . . . .	17	CTCSS Tone Frequencies . . .	31
Main Channel Scan . . . . .	18		

## FCC NOTICE

The FCC requires that you be advised of certain requirements involving the use of this device. This equipment has been tested and found to comply with the limits for a Class B digital device, pursuant to Part 15 of the FCC Rules. These limits are designed to provide reasonable protection against harmful interference in a residential installation. This equipment uses and can generate radio frequency energy. If not installed and used in accordance with the instructions, it may cause harmful interference to radio communications. However, there is no guarantee that the interference will not occur in a particular installation. If this equipment does cause harmful interference to radio or television reception (which can be determined by turning the equipment off and on), the user is encouraged to correct the interference by one or more of the following measures:

- Reorient or relocate the receiving antenna.
- Increase the separation between the equipment and receiver.
- Connect the equipment to an outlet on a circuit different from that to which the receiver is connected.
- Consult the manufacturer for technical assistance.

**FCC INFORMATION** : This device complies with Part 15 of the FCC Rules. Operation is subject to the following two conditions:(1) This device may not cause harmful interference, and (2) this device must accept any interference received, including interference that may cause undesired operation. Privacy of communications may not be ensured when using this equipment.

## Features

- \* 15 Channel and 38 CTCSS
- \* Channel Scan & Dual Watch
- \* VOX
- \* RSSI(Received Signal Strength Indicator)
- \* Call Signal (3 ringer signal)
- \* Key Tone On/Off
- \* Auto Power Save
- \* Monitor
- \* LCD Back Lighting
- \* Low Battery Indicator
- \* Roger Beep Tone
- \* Keypad Lock
- \* TX/RX LED Indicator
- \* Power Hi/Low
- \* Charging by wall charger or Desk-Top(not included)
- \* Must be using rechargeable batteries to recharge, DO NOT TRY TO RECHARGE STANDARD BATTERIES.

## Controls and Indicators

1. Power On / Off and Volume Control
2. Up Channel
3. Down Channel
4. SCAN / Lock Button
5. Built-In Speaker
6. External Speaker Jack and Mic Jack (under rubber flap)
7. Antenna
8. Transmit / Receive LED Indicator
9. LCD Screen
10. CALL Button
11. MODE Button
12. Built-In Microphone

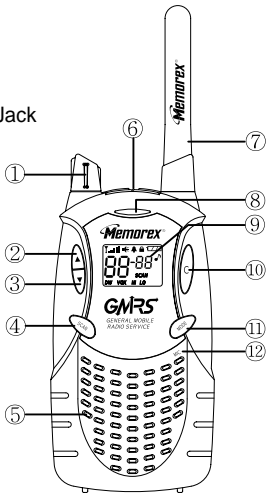

## Controls and Indicators

- 13. Charging Terminals
- 14. Push-to-Talk (PTT) Button
- 15. MONITOR/Backlighting Button
- 16. Detachable Belt Clip
- 17. Battery Door

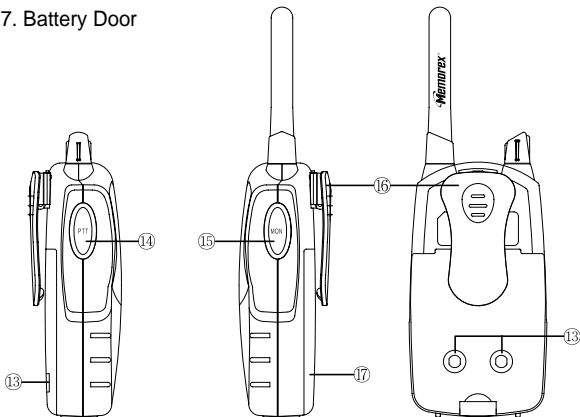

## LCD Display Indicators

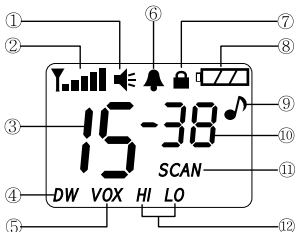

- |                              |                                 |
|------------------------------|---------------------------------|
| 1. Monitor Indicator         | 7. Key Lock Indicator           |
| 2. Signal Strength Indicator | 8. Battery Level Indicator      |
| 3. Main Channel Indicator    | 9. Beep Tone Indicator          |
| 4. Dual Watch Mode Indicator | 10. CTCSS Sub-Channel Indicator |
| 5. VOX Indicator             | 11. Scan Indicator              |
| 6. Roger Beep Indicator      | 12. TX Power Hi/Low Indicator   |

**Note :** The Battery icon at the top right of the display will indicate the battery power left in the installed batteries, or rechargeable battery pack. Replace the batteries, or charge the rechargeable battery pack when the Battery icon blinks.



# Operation

## Installing The Batteries

Remove the Battery Clip(if installed).

1. Pull locking tab located at the bottom of the battery compartment down and lift the door up to remove the battery cover.
2. Insert four "AA" size batteries (or Rechargeable Battery Pack)  
Position batteries according to polarity markings.

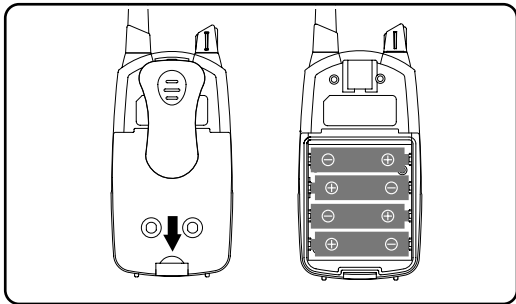

## Operation

### Recharging The Batteries

You can charge your GMRS radio by using an AC/DC wall adaptor or a desktop adaptor. Both chargers are not included, but can be purchased separately.

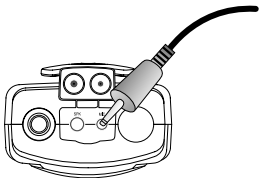

Plug in the AC/DC Wall charger as shown



Place the radio into the cradle as shown

**Note :** Do not charge unit using an AC/DC adapter with regular **AA ALKALINE BATTERIES** installed. Only use the AC/DC adaptor with **AA NI-MH RECHARGEABLE BATTERIES**. (Charger and rechargeable batteries not included.)

# Operation

## Turning On Your Unit

Rotate On/Off Volume control knob “clockwise”. An audible tone will indicate the unit is on and then the LCD will go to operation mode.

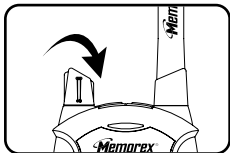

**Note** : Whenever the unit is on, you can receive communications.

## Adjusting The Volume

Rotate the Power On/Off Volume control knob “clockwise” or “counter clockwise” to adjust the volume level.



## Talking To Another Party

To send your outgoing message and to communicate with another party,

1. Press and hold the PTT button to transmit your message.
2. Release the PTT button to hear the person you are talking to.
3. While the PTT button is depressed, you can not receive incoming calls.

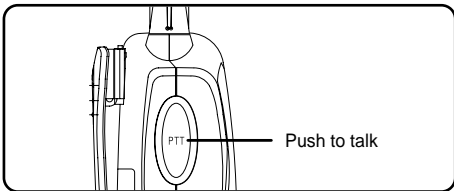
# Operation



**Note :** When you press and hold the PTT button, the signal strength indicator will be displayed to confirm TX signal strength Hi (  ) or Low (  ).

## Mode Button

This button is used to select various feature settings in your MK 1995 GMRS Radio.

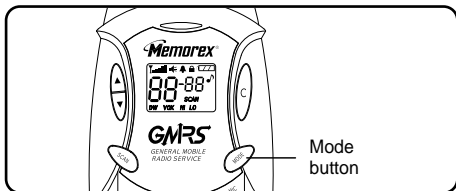

## Operation

**Note :** After the MODE button is pressed, the Up(▲) or Down(▼) button must be pressed within 8 seconds, otherwise, the unit will revert back to Normal mode.

### Selecting Main Channels (1-15)

Your MK1995 GMRS Radio has 15 main channels.

To select the channel,

Press the Up(▲) or Down(▼) button to select the desired channel.

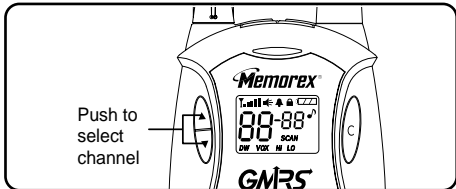

## Operation

### Selecting Tone Code (CTCSS Sub-Channel)

This feature allows you to utilize the coded squelch tones (00~38) within one of the 15 main channels. This enables you to communicate with another party on the same main channel using the same sub-channel and filters out unwanted transmissions without the same coded tone code.

To Select the CTCSS Sub-Channels,

1. While in the normal mode (not scan mode), press the MODE button once.
2. A flashing sub-channel number will be displayed on the LCD screen.
3. Press the Up(▲) or Down(▼) button to select the desired sub-channel.
4. Press the MODE button 7 times, or simply press the PTT button once to set the channel, and exit from the CTCSS selecting mode.

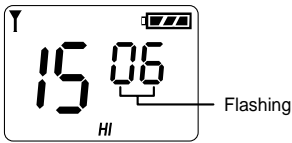
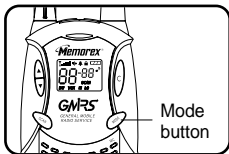

## Operation

### Transmit Power Hi/Low

Your MK1995 Radio permits selection of the transmitting power level to High (2W) or Low (0.5W).

1. Press the MODE button twice and the Power ( P<sub>O</sub> ) icon and level will appear on the LCD screen.
2. Select Hi or Low by pressing the Up(▲) or Down(▼) button.
3. To exit from the Transmit power selection mode by pressing the MODE button 6 times, or simply pressing the PTT button.

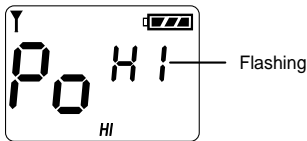

# Operation

## Dual Watch Mode

This feature allows you to monitor two channels at the same time. While in dual watch mode, the unit will continuously monitor both the primary and dual watch channel. Received signals will be heard for 5 seconds, then the unit will resume scanning the two channels. Pressing the PTT button during a received transmission will set the unit to transmit on the same channel. Pressing the PTT button when no signal is received will set the unit to transmit on the primary channel.

To set the Dual Watch Mode,

1. Press the MODE button 3 times until the ( *DW* ) icon is flashing.
2. Select the desired channel by pressing the Up(▲) or Down(▼) button.
3. Press the PTT button or the MODE button 5 times to exit from the selecting mode.
4. Press the SCAN button momentarily to cancel the dual watch mode.

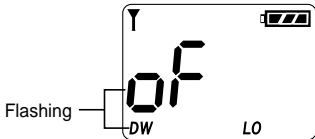



# Operation

## VOX Mode

This feature enables you to have hands-free conversation. Your voice or nearby sound is detected and the radio transmits without the need to press the PTT button.

To set the radio for VOX operation,

1. Press the MODE button 4 times, and the ( *vox* ) icon will appear and flashing on the LCD screen.
2. Press the Up(▲) or Down(▼) button to select VOX off and from 1 to 3 VOX level sensitivity. The higher the number, the higher the sensitivity.
3. To exit from the VOX selection mode by pressing the MODE button 4 times, or simply pressing the PTT button.
4. Vox can be turned off by selecting “oF” as the setting.

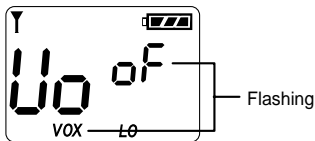

**Note :** The VOX icon will be displayed on the LCD screen after setting. When you are in VOX operation, Roger Beep will be disabled.

# Operation

## Key Tone Setting

This feature allows the radio to sound a confirmation beep tone whenever keys are pressed.

To turn the key tones on or off,

1. Press the MODE button 5 times until the ( 🎵 ) icon is flashing on the LCD screen.
2. Press the Up(▲) or Down(▼) button to enable (“On” will appear on the LCD) or disable (“Off” will appear on the LCD screen) the key tone feature.
3. To exit from the selecting mode, press MODE button 4 times, or simply press the PTT button once.

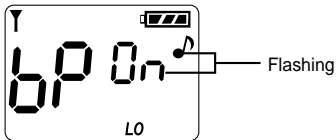

**Note :** When the key tone is on, the ( 🎵 ) icon will be displayed on LCD screen.

# Operation

## Roger Beep Tone

The Roger Beep is a tone which is automatically transmitted whenever the PTT button is released.

To enable or disable the Roger Beep Tone,

1. Press the MODE button 6 times until the ( 📣 ) icon is flashing on the LCD screen.
2. Press the Up(▲) or Down(▼) button to enable ( “ 0n ” will appear on the LCD) or disable ( “ 0F ” will appear on the LCD) the Roger Beep Tone feature. When enabled, the ( 📣 ) icon will appear on the LCD screen.
3. To exit from the Roger Beep Tone feature, press the MODE button 2 times, or simply press the PTT button.

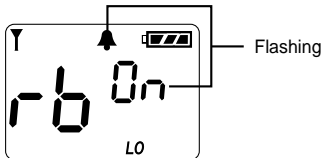

## Operation

### Selecting Call Tones

Your MK1995 GMRS radio provides 3 user selectable call tones to alert you of an incoming signal.

To select your favorite call tones,

1. Press the MODE button 7 times and “CA” will appear on the LCD screen.
2. Push the Up(▲) or Down(▼) button to select your favorite call tone.
3. Press the MODE button once to exit from the Call Tone selection mode, or simply press the PTT button once.

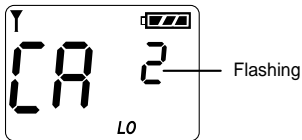

# Operation

## Main Channel Scan

This feature allows you to monitor all channels automatically for valid signals. While scanning, you can transmit and receive. When a signal is received, scan is interrupted and you will hear the channel for 5 seconds. After the 5 seconds, the unit will resume scanning unless the Scan button is pressed again as described below.

1. To start Scan mode, press the SCAN button momentarily.  
The ( **SCAN** ) icon will be displayed on the LCD screen and the unit will scan through the 15 channels to find an active channel. When an active channel is found, it will be heard for 5 seconds, and then scanning will resume.
2. If the unit does not locate an active signal and you would like to transmit, press the PTT button to return to home channel operation. After approximately 5 seconds after the communication is completed, the transceiver will automatically resume scanning.
3. To exit from the Scan mode, press the SCAN button again. The unit will return to normal operation and the ( **SCAN** ) icon will disappear from the LCD screen.

# Operation

## CTCSS Sub-Channel Scan

This feature will scan all CTCSS sub-channels. It will pause to hear any active transmissions for 5 seconds, and will resume scanning in order.

To activate the CTCSS scan mode,

1. Press the MODE button once to select the CTCSS function. The sub-channel digits will blink in the LCD screen.
2. Press the SCAN button. The radio will start scanning for all sub-channels (01~38).
3. To disable the Sub-Channel scan, press the SCAN button again. The radio will return to normal operation, and the last sub-channel will be memorized.

## Key Lock

This feature prevents accidental channel change to the preferred settings of the unit. The Key Lock function will temporarily disable the Channel Up/Down, Scan, and Mode button.

To activate Key Lock :

1. Press and hold the SCAN button for 2 seconds. The key Lock icon (  ) will appear on the LCD screen and the Key Lock function will be activated.

## Operation

2. To unlock the Key Lock function, press and hold the SCAN button for 2 seconds. The (🔒) icon will disappear and normal operation will resume.

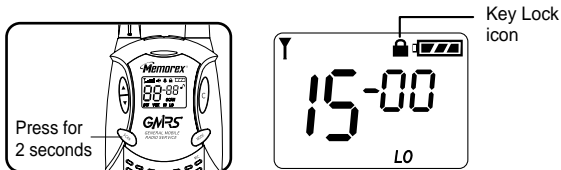

### Calling Another Party

To alert another party that you wish to communicate with,

1. Select a desired channel by pressing the Up(▲) or Down(▼) button.
2. Press the Call(C) button.
3. Wait for the party's response or proceed to talking with the other party.

**Note** : Both the calling and receiving units must be on the same main channel and sub-channel for the call function to work. When Call(C) button is pressed, Signal Strength indicator and TX/RX LED indicator will turn on.

# Operation

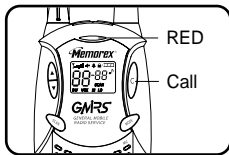

## Monitor

Your MK 1995 radio has the feature to check for weak signals in the current channel.

1. Press and hold the Monitor (MON) button for 2 seconds until the Monitor (🔊) icon appears on the LCD screen and the signal is heard.
2. To return to normal operation, press and hold the Monitor (MON) button for 2 seconds again.

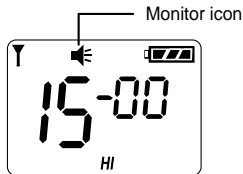
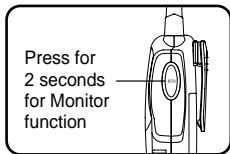



## Operation

### LCD Back-Lighting Lamp

This lamp is used to illuminate the LCD screen. It turns on every time you press and release the monitor (MON) button momentarily. The lamp will go out after 4 seconds.

### TX / RX Indicator LED Lamp

When the PTT button is pressed, the red (TX) LED will light to confirm transmitting signal. When you are receiving signals from another party, the green (RX) LED will light.

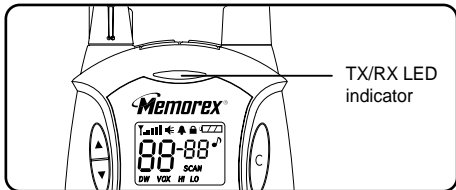

### Auto Power Saver

Your MK1995 unit has a unique circuit designed to extend battery life. If there are no transmissions within 5 seconds, the unit will automatically switch to Battery Save Mode.

## Operation

**Note** : The Auto Battery Save Circuit does not effect the unit's ability to receive incoming transmissions.

### Low Battery Indicator

When the batteries are low and need re-charging, the (  ) icon will be blinking and audible beep tones will sound.

If using standard batteries, replace them. If using rechargeable batteries, recharge them.

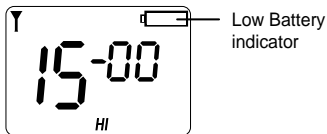

## External Microphone/Speaker

### External Microphone Jack

Your MK1995 has an external microphone jack which enables you to connect an external microphone in order to free your hands for other tasks.

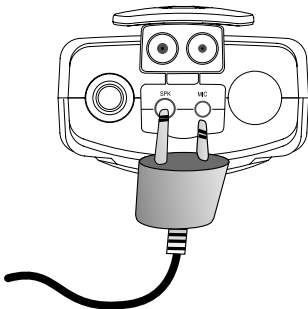

Simply raise the rubber flap and insert the microphone plug into the microphone jack on the top of the unit.

**Note** : External speaker and microphone are not included with this standard package.

## Notes for Better Communication

1. Your MK1995 GMRS radio has been designed to maximize performance and improve transmission range in the field. To avoid interference, it is recommended that you do not use the unit closer than 5 feet from another unit.
2. For better transmission results, keep your mouth about 2-3 inches from the microphone and speak slowly in a normal voice.
3. Reverse polarity( + / - ) may cause serious damage to the unit. Make sure not to reverse the polarity( + / - ) of the batteries in the battery compartment.

## Special Warning

1. Do not operate the transceiver unless you are licensed to do so.
2. Avoid exposing the transceiver to water or extreme temperatures.
3. Do not attempt to modify or in any way increase the output of this transceiver. Its output is designed to meet the legal limits set by the FCC.
4. Do not use this device or change its batteries in potentially explosive atmospheres as sparks in such areas could result in an explosion.
5. Turn your transceiver off wherever posted notices restrict the use of radios or cellular phones. Facilities such as hospitals may use equipment that is sensitive to RF energy.

## Troubleshooting Guide

Problem	Possible Cause	Correction
No transmission while pressing the PTT button.	Weak batteries.	Charge or replace batteries.
Unit is on, but will not be operated.	Incorrect battery polarity.	Install the batteries following the polarity diagram inside the battery compartment.
Weak or no signal received.	Weak batteries.	Charge or replace batteries.
	Channel or Tone Code not set the same as target transceiver.	Adjust the unit's setting to match those settings of the target transceiver.
	Volume level too low. PTT key inadvertently depressed.	Increase volume level. Release PTT button.
	Excessive radio interference.	Change to a different channel.
Unit beeps, but will not function when turned on.	Batteries extremely discharged.	Charge or replace batteries.
Reception of unwanted signals	CTCSS not on.	Turn on CTCSS sub-tone code.

**Note :** See end of the manual for our web page and toll-free number is you need additional assistance.

## Special Note

If the batteries are not installed properly, the following can occur.  
In this case, change the batteries:

1. Same symptom as Low battery.
2. Green LED will light.
3. Cause damage to the unit.

# Specifications

## 1. General Specifications

Frequency Range (15CH GMRS)	462.5500 - 462.7250
Channel Spacing	12.5KHz
Sub-Tone Code(CTCSS)	38 for each main channel
Dimension w/o Antenna	127mm(H) x 61mm(W) x 34mm(D)
Standard Batteries	Alkaline 2400mA AA(4), 6VDC
Rechargeable Batteries	Ni-MH 1200mA AA(4), 4.8VDC
Operation Time (5-5-90)	37 hours at Hi power 57 hours at Low power

## 2. Receiver

Useable Sensitivity	> -119 dBm
Maximum Audio Output Power	> 0.3 Watt Max (8 Ohm)
Modulation Distortion	< 5%(1 KHz 70%)

## 3. Transceiver

RF Output Power	1.8W Max(at Hi)/0.5W Max(at Low)
Max Deviation	+/- 2.5 KHz
Modulation Distortion	< 5%(1 KHz 70%)



# GMRS Channel Frequencies

## Main Channel Frequencies

Channel	Frequencies(MHz)
1	462.5625
2	462.5875
3	462.6125
4	462.6375
5	462.6625
6	462.6875
7	462.7125
8	462.5750
9	462.6250
10	462.6750
11	462.5500
12	462.6000
13	462.6500
14	462.7000
15	462.7250

## GMRS Channel Frequencies

CTCSS(Continuous Tone Code Squelch System) Tone Frequencies(in Hz)

CTCSS	Freq. Hz	CTCSS	Freq. Hz
1	67.0	20	131.8
2	71.9	21	136.5
3	74.4	22	141.3
4	77.0	23	146.2
5	79.7	24	151.4
6	82.5	25	156.7
7	85.4	26	162.2
8	88.5	27	167.9
9	91.5	28	173.8
10	94.8	29	179.9
11	97.4	30	186.2
12	100.0	31	192.8
13	103.5	32	203.5
14	107.2	33	210.7
15	110.9	34	218.1
16	114.8	35	225.7
17	118.8	36	233.6
18	123.0	37	241.8
19	127.3	38	250.3



FOR ADDITIONAL SET-UP OR OPERATING ASSISTANCE, PLEASE VISIT OUR WEBSITE AT  
[WWW.MEMCORPINC.COM](http://WWW.MEMCORPINC.COM) OR CONTACT CUSTOMER SERVICE AT 1-800-919-3647  
PLEASE KEEP ALL PACKAGING MATERIAL FOR AT LEAST 90 DAYS IN CASE YOU NEED TO  
RETURN THIS PRODUCT TO YOUR PLACE OF PURCHASE OR MEMOREX. FOR PARTS AND  
ACCESSORIES, CONTACT FOX INT'L AT 1-800-321-6993.

# Memo

# Memo

**Memcorp Inc**

Weston, FL 33331

Printed in Korea

Visit our website at [www.memcorpinc.com](http://www.memcorpinc.com)